

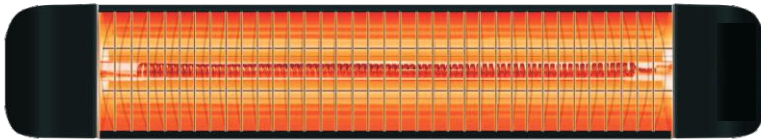



INFRARED HEATING



Wi-Fi Infrared Bar Heater Manual



Please read instructions carefully before use.

Remote control not available with all models.





Thank you for purchasing this Infrared Heater. In order to get the most out of your product, please read this manual carefully before use, and keep it in a safe place for future reference.

Suns Lifestyle, nor any of its affiliated companies are liable for any damages resulting in misuse of our heaters, nor any failure to comply with the instructions contained in this manual.

Safety Warnings:

To avoid the heater overheating, please do not cover the heater.

Should any substance or material cover the heater, or go near the heating element inside the heater, you should stop using it immediately, disconnecting it from the mains power. After disconnecting the heater from the mains, allow the heater adequate time to cool down. Once the heater has cooled down, ensure that any foreign material has been cleared from the housing of the heater, and from the heating element.

If the heater is being used in areas with high salt concentrations, like near the sea for example, then over time, salt, alkali, crystals and other foreign materials may begin to collect on the housing of the heater or on the heating element. In the event of this happening, you should stop using the heater immediately, disconnecting it from the mains power. After disconnecting the heater from the mains, allow the heater adequate time to cool down. Once the heater has cooled down, ensure that any foreign material has been cleared from the housing of the heater, and from the heating element.

Due to the intensity of the heat produced by the heater, the front should be placed a minimum of 1.5 metres away from any flammable materials, such as furniture, pillows, bedding, paper, clothes and curtains. Ensure that there is enough room either side of where the heater is installed too.

Please ensure that the heater is installed at a minimum height of 1.8 metres.



This heater should only be used with a 220-240V AC power supply. Please use the correct power supply with this heater for safe usage.



Please note that all IR Bar Heaters must be connected to a either a 10A mains supply, 13A fused spur or standard 3-pin plug socket. Please consult a qualified electrician before using the heater for anything other than home/domestic use.



The heater should not be operated or used by vulnerable people such as children, the elderly or disabled, unless there is an adult present who is responsible for their safety, who can either use the heater on their behalf, or ensure that the heater is being used on the correct manner by the vulnerable person.

Do not leave children unattended with the heater.



The fire protection grille cover on the front of the heater is to prevent direct contact with the heating element. When using the heater, the fire protection grille cover must be in place. The heater must be grounded adequately, through use of a properly grounded outlet.







When in use, please ensure that the plug, socket and heater are free of dust and dirt.



When disconnecting the heater from the mains supply, please turn off the switch at the mains socket, then unplug the heater by pulling the plug, not the power cord. Do not operate the heater or your mains supply with wet hands.

Do not extend the power cord.

Check the power cord regularly for wear and damage. Should there be any damage to the power cord, plug or socket, do not use the heater. The power cord should be replaced or repaired by either the manufacturer or a qualified electrician.

Do not use a heater that has sustained any damage or been discarded under any circumstances.

The heater should not be installed directly above the mains power supply or socket.

The power cord should be safely tucked away behind the heater when in use, and should not be placed in front of the heater, or hung off it.

Do not use the heater in areas with gasoline, paint or other flammable liquids or materials are stored.

If the heater is installed in a bathroom, please ensure it is installed as far away as possible from any bath tub, shower, sink or toilet. The heater should not be installed in such a location where it could fall into a bath tub or any other water container.

Take extra care when leaving the heater running whilst unattended, or when asleep.

Do not insert anything into the heater.

Do not touch the heater when in use, and ensure that the heater has been off for a considerable length of time before touching it.

Should you need to move the heater, please ensure you disconnect it from the mains supply, give it ample time to cool down before moving it.

Model				
Voltage	220-240V AC	220-240V AC	220-240V AC	220-240V AC
Amps	5A	5A	10A	10A
Power	1200W	1200W	2400W	2400W
Product Size	770 x 160 x 80mm	770 x 160 x 80mm	970 x 160 x 80mm	970 x 160 x 80mm

Installation Notes

This heater should be installed by a qualified electrician.

Before and during the installation, please ensure that the heater is disconnected from the power, and that the heater has cooled down if it has been on.

The heater can be installed both horizontally and vertically.

The heater must be installed at a minimum height of 1.8m above the floor, OR at such a height that it cannot be touched directly whilst on.

When installing on the wall, ensure that the heater is installed at an angle no more than 90° in relation to the wall, and no less than 45° in relation to the wall.

When installing the heater on the ceiling, ensure that it is either facing directly downwards, or at an angle no less than 45° in relation to the ceiling.

When installing the heater vertically, please ensure that the power cord is at the bottom of the heater.

When the heater is on, the body of the heater will increase, so please ensure that the power cord is tucked away safely and never comes into contact with the body of the heater.

Do not install the heater near any flammable materials.

Ensure that the heater is installed at a minimum of 150mm away from ceilings and walls.

For outdoor installations, please use a weatherproof power socket suitable for outdoor use.

Before drilling into any walls for installation, please ensure there are no wires, water pipes or gas pipes in the area where the heater is being installed.

The heater must be installed using the mounting brackets provided with the heater from the manufacturer.

Heater Installation Instructions

Contents:

- (A) 4 x wall brackets
- (B) 2 x 15mm screw
- (C) 2 x large wing nut
- (D) 4 x small wing nut
- (E) 4 x 60mm screw
- (F) 4 x large wall plugs
- (G) 2 x 12mm screw
- (H) 2 x small wall plugs
- (I) 1 x remote bracket

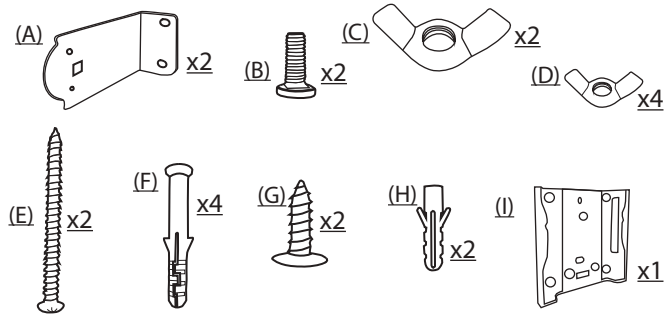
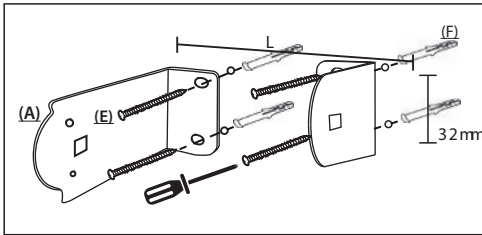

Figure A:



Remove the accessories from the accessory bag. Drill two holes in the wall, each with an 8mm diameter, and depth of approximately 70mm, 32mm apart vertically. Another two holes identical to this should be drilled no further than 450mm away horizontally. Install the large wall plugs (F) into the holes, and then mount the wall bracket (A) onto the wall using the 60mm screws.

Take the remaining two wall brackets (A), and affix them to the back of the bar heater using the screws already on its back, using the small wing nuts (D).

Figure B:

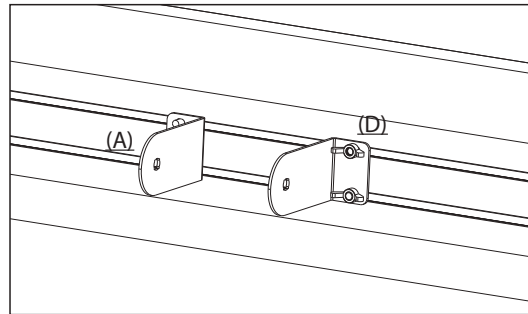
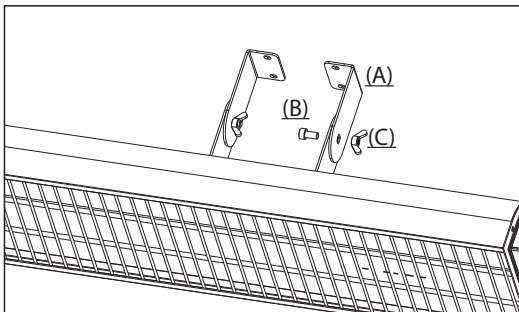

Figure C:



Using the 15mm screw (B) and large wing nut (C), join the brackets on the wall to the brackets on the back of the bar heater, tilting the angle to your desired setting, and tightening the brackets using the wing nut.

Remote Installation Instructions

Please note that the following instructions are only applicable to the remote control (MS-QHA-12W and MS-QHA-24W) models.

The remote control can be used either as a wall mounted unit, or as a conventional remote control.

To mount it on the wall, drill two holes approximately 40mm apart vertically, at a depth of approximately 30mm.

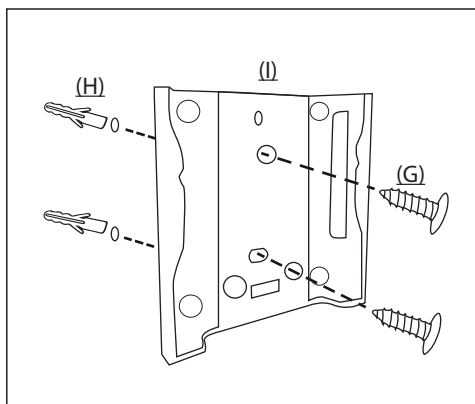

Insert the two small wall plugs (H) into the holes, before affixing the bracket to the wall using the two 12mm screws. Ensure that the base of the bracket is at the bottom before screwing it in.

The remote can then affix to the bracket using the grooves down its side. Push the remote down until you hear a click.

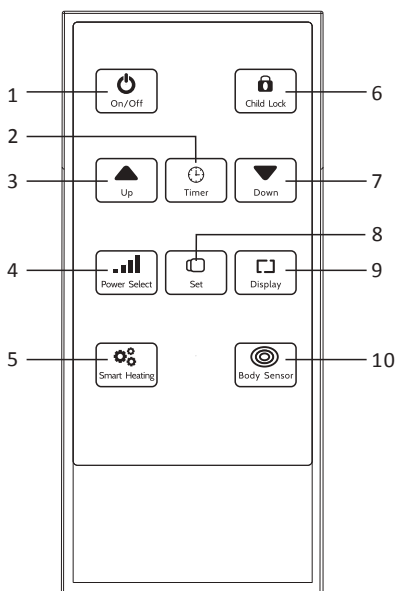

1. On/off button
2. Timer button
3. Up button
4. Power level button
5. Smart Heating button
6. Child lock button
7. Down button
8. Set button
9. Display button
10. Body Sensor button

Please note that the following instructions are only applicable to the remote control (MS-QHA-12W and MS-QHA-24W) models.

- Plug the heater into the mains power, ensuring that the socket matches the voltage and current of the nameplate on the back of the panel.
- Press the On/off button to switch the heater on and off.
- Use the Up button and Down button to alter the desired temperature. The lowest possible temperature is 5°C, and the highest temperature is 45°C.
- Press the Power level button to switch between the four levels of power. This will alter the intensity of heat emitted from the bar heater.
- Pressing the Timer button will open the timer setting. You can select any time range between 0 hours and 24 hours, in 1-hour increments. When you are happy with your selection, leave the remote for 5 seconds and your timer setting will apply. The timer icon will appear on the screen to indicate that it has been applied.
- Pressing the Display button will switch everything off on the screen except for the current temperature. Pressing it again will switch the display back on. Pressing the Display button twice quickly will switch everything off on the display except for the heating on icon. To bring the screen back on, press the Display button once.
- Pressing the Smart Heating button will toggle smart heating on, where the heater will automatically adjust the power level to maintain your temperature. The intelligent heating icon will appear on the display when this mode is on.
- Pressing the Body Sensor button will switch Body Sensing mode on. The bar heater will now begin to detect moving objects in the area, and will only operate as long as it can sense movement. If the bar heater does not detect any movement for 2 minutes, it will switch off.
- To lock the heater, press the Set button followed by the Child Lock button. Repeat the process to unlock the heater.
- Pressing the Set button followed by the Up button will toggle the display between Celsius to Fahrenheit.
- Pressing the Set button followed by the Down button resets the Wi-Fi setting for the Bar Heater. Once reset, the Wi-Fi symbol will begin to flash on the display.
- Pressing the Set button followed by the Power Level button will switch the Open Window Detection mode on. The symbol "WO" will appear on the display when activated. When on, if the heater detects a drop in ambient temperature of 3 degrees within a 2-minute time frame, it will switch off as it will assume a window has been opened. Pressing the Set button followed by the Power Level button again will switch Open Window Detection off.
- Pressing the Set button followed by the Display button displays the current voltage on the screen.

Using The Smart Life App

1. Connect your smartphone or tablet to your Wi-Fi network. (The wireless network must be 2.4GHz. All Wi-Fi routers have a 2.4GHz band, however, some newer routers are dual band with both 2.4GHz and 5GHz. When scanning your available networks, if you see a single network belonging to you, then this will be the correct band. If you see two networks, the name of the network should help you identify which band it belongs to, so a 2.4GHz network will have 24G, 2.4, 24 or something similar in the name, whilst the 5GHz network will have 5 or 5G in the name).
2. Scan the QR code on the next page using your phone or tablet to download the Smart Life app, or simply search 'smart life' in your app store. The icon for the app is displayed below.
3. If you don't already have an account, set one up using either your phone number or email address by clicking Register. Keep your password in a safe place.
4. Once you're set up, click either "Add Device" in the centre of the screen, or the "+" icon in the top right corner.
5. On the next screen, under the "Small Home Appliances" category on the left, scroll down and select "Heater" in the "Life" subcategory (Fig. 1).
6. Next, the heater needs to be placed in pairing mode – you can do this by quickly pressing the on/off switch at the back of the panel 3-5 times until you see the LED light on the front of the panel blink red and blue rapidly.
7. Now on the app, confirm that the light is blinking rapidly, and enter your Wi-Fi network information (the name of the network and the password) (Fig. 2).
8. The app will now scan for the heater, and connect once it has paired.
9. If the panel light blinks red on and off slowly (once every 2 seconds), then you need to click "Other Mode" in the top right corner of the blinking indicator confirmation screen (Fig. 3), and choose "AP Mode". If your heater is already paired then you can skip the remaining steps.
10. Confirm on the next screen that the LED light is blinking slowly (Fig. 4).
11. Enter your Wi-Fi network details on the next screen (network name and password), before connecting your phone to a new Wi-Fi network named "SmartLife_XXXX" where the "XXXX" will be randomised numbers (Fig. 5).
12. Once you're connected to "SmartLife_XXXX", click the button that says "Confirm the hot spot, next" (Fig. 6), and the app will begin attempts to connect to the wireless temperature sensor.
13. Once connected, you will see "Device added successfully" on your screen, and you will see the control menu on your screen (Fig. 7).



Figure 1:

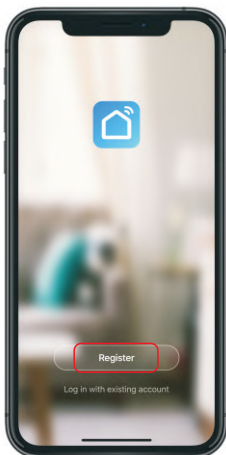

Figure 2:

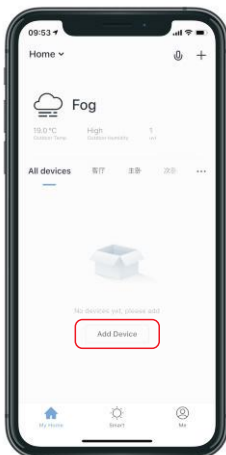

Figure 3:

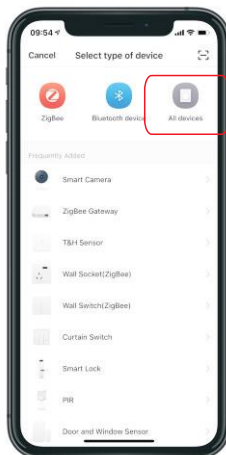

Figure 4:

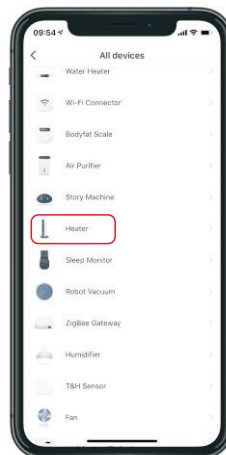

Figure 5:

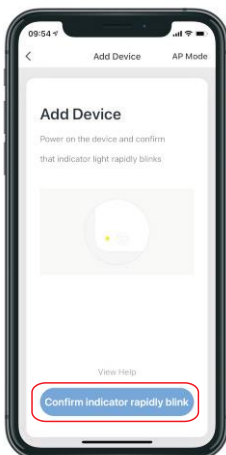

Figure 6:

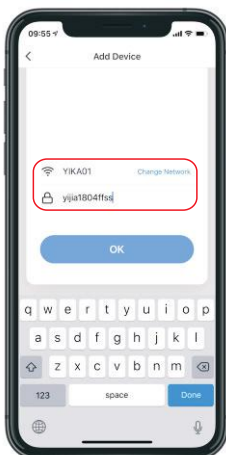
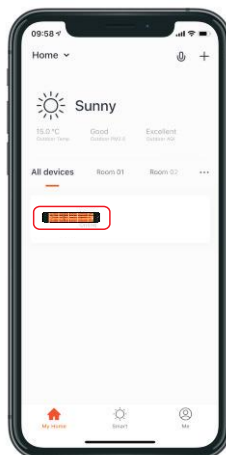

Figure 7:

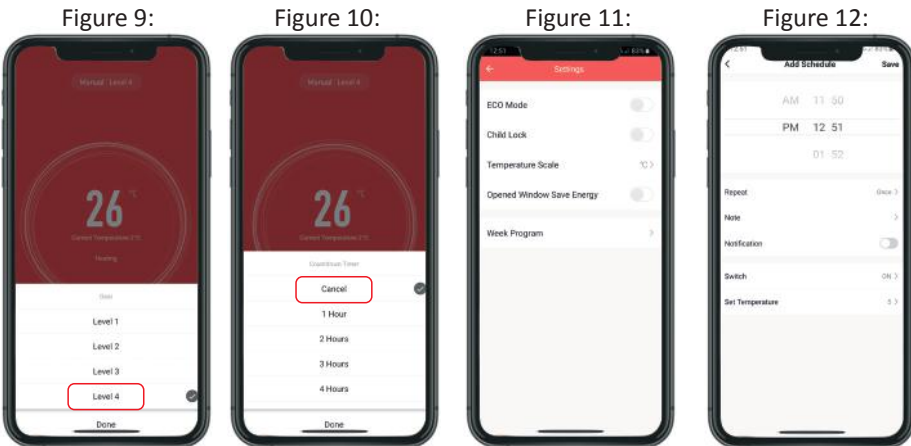

Figure 8:



Controlling Your Heater

1. On the main control menu, you will see your desired room temperature in the middle of the screen (Fig. 7). Beneath that, you will see the current room temperature. Use the “+” and “-” buttons to adjust this up and down accordingly. If the target temperature is higher than the current room temperature by 0.5°C or more, it will switch on, and if the target temperature is lower than the current room temperature by 0.5°C, it will switch off.
2. Pressing the “Mode” button along the bottom will allow you to choose between Manual heating, Smart heating and Body Sensing heating (Fig. 8).
3. Pressing the “Gear” button allows you to select the intensity of heat emitted by the bar heater (Fig. 9).
4. Pressing the “Countdown Timer” button allows you to set how many hours you would like your bar heater on for, ranging between 1 and 24 hours (Fig. 10)
5. Pressing the “Eco button allows you to tweak various settings on your bar heater (Fig. 11). Here, you can toggle the Display on and off, the Child Lock settings, the temperature display in degrees Celsius or degrees Fahrenheit, the open window detection, and the weekly timer.
6. The use the weekly timer, enter the weekly timer menu and click “Add” in the middle of the screen. You will then be able to set what time you want your bar heater to come on or off (Fig. 12) by selecting the time you want it to come on or off, how often you would like to repeat this setting, any notes for the setting, notifications for when this setting happens, whether you want the heater to switch on or off and the temperature you would like the room to be. Click “Save” when you are done, and if you would like to add another setting, click “Add Schedule” at the bottom of the screen.



Using The 7-Day Timer With Your Heater

1. On the home screen of the Smart Life app, press the 'Timer' button in the bottom right corner.
2. Then, press 'Add' in the middle of your screen.
3. The following screen allows you to set your timer settings:
4. Use the sliders at the top of the screen to set what time you want your heater to switch on or off.
5. Press the 'Repeat' button to set which days you would like the timer to occur on, if any.
6. Press the 'Note' button to set a note for that particular timer setting.
7. Press the 'Switch' button to set whether you want the heater to switch on or off at the time you have set.

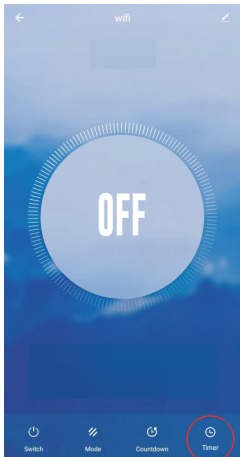

Figure 1

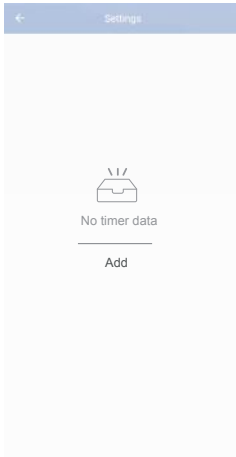

Figure 2

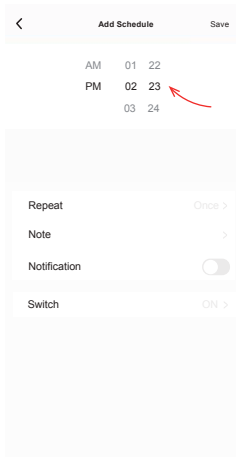

Figure 3

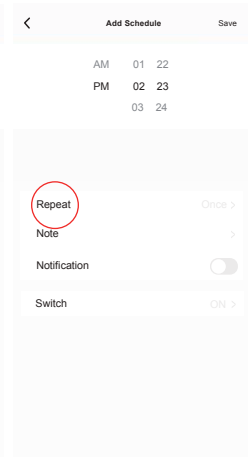

Figure 4

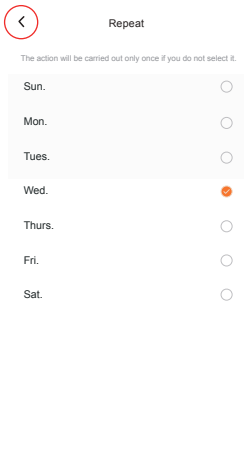

Figure 5

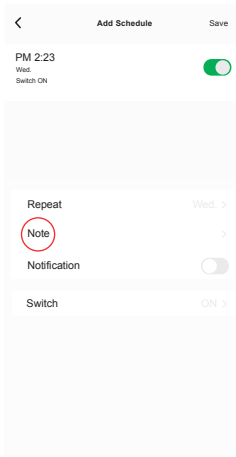

Figure 6

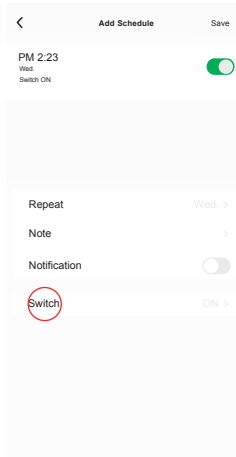

Figure 7

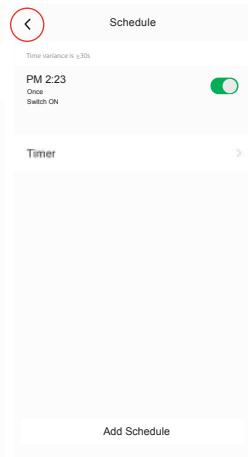

Figure 8





Cleaning & Maintenance

- If the inside of the heater becomes covered or clogged up with dust or dirt, please have it cleaned from a qualified service engineer, and do not operate the heater in this state.
- Only clean the exterior of the heater.
- When cleaning the heater, always disconnect the heater from the mains supply, and give the heater adequate time to cool down before cleaning it.
- Do not use solvent cleaners or abrasive materials when cleaning the heater, as this can damage the exterior. Instead, use a mildly damp cloth.
- Do not touch the heating element with your fingers, as not only can this pose a significant risk of injury, but it can also potentially damage the heating element too.
- Do not attempt the repair or adjustment of any mechanical functions of this heater.
- If the heater is damaged or defective, it must be returned to the manufacturer or repaired by a qualified professional, as there are many non-user-serviceable parts in the heater.